Chapter 11

Fencing

Brian Freking

Producers have numerous fencing options for the confinement and protection of livestock. Many traditional materials such as barbed and woven wire fences are suitable for fencing. However, newer materials including high-tensile wire also should be considered prior to selecting a fencing type. The fencing type should be selected for maximum effectiveness of individual fencing needs. Fencing materials should provide the longest life and lowest maintenance to optimize livestock confinement and protection. Routine inspection and maintenance is helpful in giving long and trouble-free service.

Fencing Considerations

Horned Goats

Special consideration must be given to fencing for horned goats. Fencing should prevent horned goats from placing their heads on the other side of the fence or should have openings large enough to let animals slide their head through the fence and back. Permanent electric fences also make good fences for horned goats.

Predator Control

Predator control is another important consideration for goat fencing. Five-strand high tensile electric fence is particularly useful for discouraging predators such as dogs and coyotes. However, fences must be kept free of vegetation to maintain electric current on the fence.

Coyotes can pass through openings as small as 4 ½ inches. Some manufacturers produce fencing with bottom openings of 6 by 3 inches for predator control and 3 by 3 inches for predator proofing.

Goat Fencing

Several options currently are available for goat operations that include barbed wire, cable, woven wire, net wire and electric fencing.

Factors for selecting a fencing type include affordability, maintenance, durability and effectiveness of containing livestock. Fencing types vary from physical barriers such as woven wire and

board fences to psychological barriers such as electrified poly wire or tape. High-tensile electric fences are a combination of both barrier types.

Barbed Wire

Barbed wire is the most common fence material, which can be made goat proof. Most barbed wire fences in Oklahoma are four or five strands and are very good at holding cattle, but very poor for holding goats. Barbed wire fences do not effectively confine goats, if higher grazing pressures are applied to the fenced-in area. Goat-proof barbed wire fences require at least five to six wires with the spacing on the bottom starting at 3 inches and increasing to 5 inches at the top.

Standard barbed wire fencing usually has three to five strands stretched between posts. The typical fence height is either 51 or 54 inches. Spacing between wires depends on the number of line wires and the fence height as shown in Figure 11-1. Line posts usually are spaced 12 to 20 feet apart.

Suspension barbed wire fencing consist of four to six strands of 12 ½-gauge barbed wire stretched tight, so no more than 3 inches of sag exists between posts. The wire strands are held apart by twisted wire stays, plastic battens or droppers spaced 16-feet apart. Line posts usually are spaced 80 to 120 feet apart. An important aspect of this fencing is that H-braces or corner posts must be very stable and must resist up-heaving and kick out.

NOTE: Never electrify barbed wire.

Woven Wire

Heavy or extra heavyweight woven wire fencing, shown in Figure 11-2, are excellent for goats. Fence height should be at least 39 inches high to prevent animals from climbing over the fence. However, fence height depends on the breed to be confined.

Woven wire fencing consists of smooth horizontal (line) wires held apart by vertical (stay) wires. Spacing between line wires may vary from 1 ½ inches at the bottom for small animals to 9 inches at the top for large animals. Wire spacing generally increases with fence height.

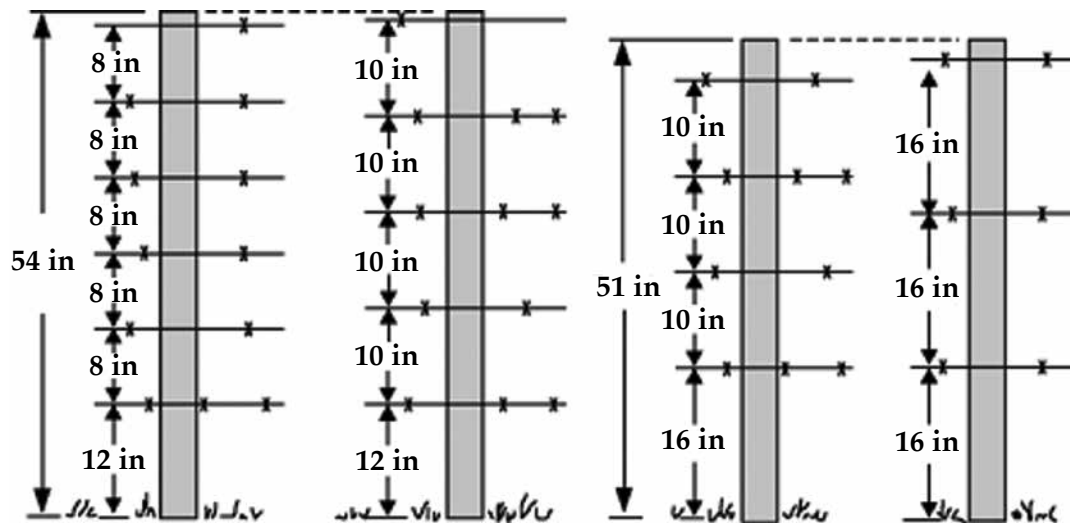

Figure 11-1. Barbed wire fencing.

Woven wire fences are available in numerous combinations of wire sizes and spacing, number of line wires and heights. Most fences range in height from 26 to 48 inches. Stay wires should be spaced 6 inches apart for small animals and 12 inches apart for large animals.

The standard design numbers listed on the manufacturer's tag (attached to fence rolls) describe the fence, illustrated in Figure 11-2. For example, a design number of 1047-12-11 indicates that the fence has 10 line wires and is 47 inches high, has 12 inches of spacing between stay wires, and has 11-gauge filler wires (wires between the top and bottom line wires).

Woven wire fencing is excellent for predator control. One strand of high tensile electric wire can be used at the bottom of a woven wire fence. If electric wire is not used, the fence bottom should be placed on the ground to allow for the use of snares where predators dig under the fence. At least one manufacturer makes woven wire fencing with stay wires attached to line wires with a fixed knot. This prevents predators from sliding apart the stay wires and entering the confined area.

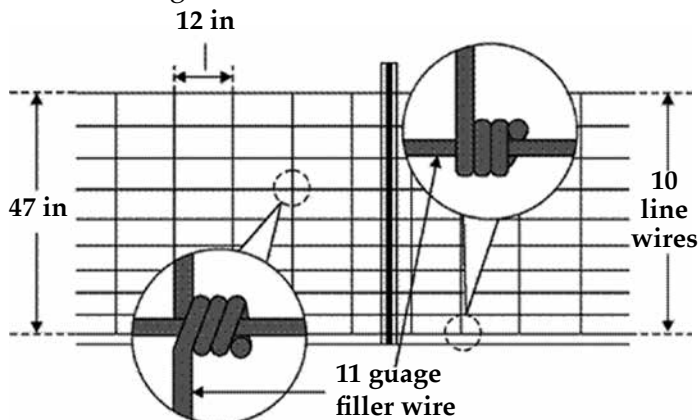

Figure 11-2. Woven wire fencing.

Cable Wire Fencing

Cable wire fencing is expensive and generally is used for confinement areas. This fencing consists of 3/8-inch steel wire cables stretched between anchor posts. Fence height varies from 60 inches for a four-cable fence to 72 inches for a six-cable fence.

A heavy-duty spring is fixed to one end of each cable and attached to an anchor post to absorb the shock on the wires caused by animal contact. The fence may consist of as many cables as desired, although a six-cable fence is recommended for large animals. This fence has become less popular in recent years; the 10-strand high-tensile electric fence has taken its place.

Mesh Wire Fencing

Mesh wire fencing is made in 11, 12 1/2, 14 and 16 gauges, and fences are available in diamond-mesh and square knot designs. Fence height generally varies from 50 to 72 inches. The square knot wire design is formed from single line wires spaced 4 inches apart and stay wires spaced 2 inches apart (Figure 11-3). The joints are held by a piece of short wire formed into a knot.

The diamond-mesh wire design uses two smooth wires spaced 4 inches apart, which are twisted together for all line wires, shown in Figure 11-4. Stay wires consist of single smooth wires the same size as the line wires. These stay wires are wrapped around adjacent line wires to form a triangle with a 2-inch base. The diamond shape is formed when two of these triangle bases are fitted together.

Both mesh fence designs are strong and highly safe for animals. However, these fences are expensive and used primarily for confinement areas or small acreages. Mesh wire fence is priced similarly to woven wire fence on a per-roll basis, although

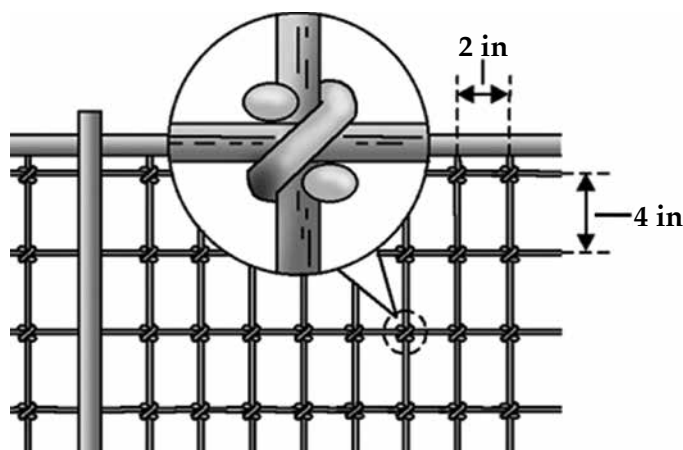

Figure 11-3 Mesh wire fencing.

mesh wire rolls typically contain one-third of the fence length found in woven wire rolls.

Board Fencing

Board fencing is made from 1- to 2-inch thick by 4- to 6-inch wide boards nailed to flat-sided wooden posts. Board fences can be built to any height, although 4 ½- and 5-foot heights are most common.

Posts typically are spaced every 8 feet. However, board length should always be checked before deciding on spacing. For example, if 16-foot boards are purchased, the posts can not be driven straight enough to attach the boards every 8 feet and post spacing must be decreased.

Board fences are strong, attractive and safe for animals. However, these fences are often built incorrectly by placing the boards on the wrong side of the post to maintain aesthetics. The boards should always be attached to the side of the post facing the livestock. Otherwise, animals tend to push boards off the post when they lean or push against the fence.

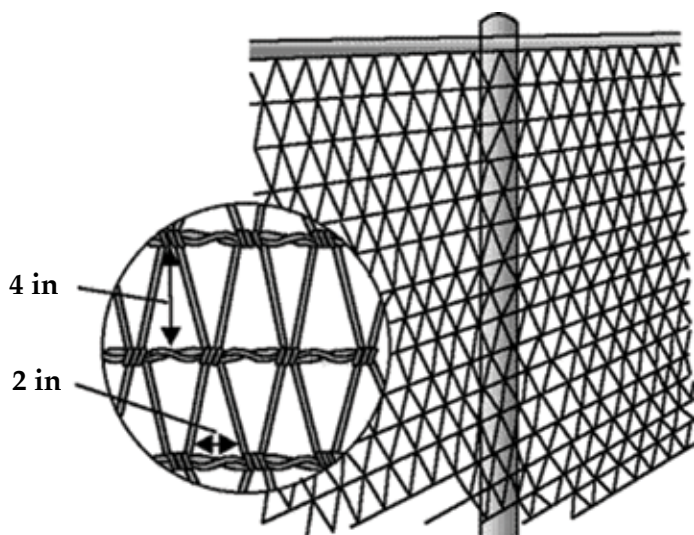

Figure 11-4. Diamond wire fencing.

Board fences are expensive to build and maintain. Furthermore, the addition of one or more boards significantly increases the amount of materials needed or the labor required to build and maintain the fence. Labor is considerably higher for board fences than for most wire fences. Other disadvantages include the boards splintering, breaking and rotting.

High-Tensile Fencing

High-tensile fencing is easy to handle, requires little maintenance, and can be relatively low-cost. This type of fencing can withstand livestock contact and low temperature contraction without losing its elasticity. With time, high-tensile wire has less stretch or sag, which is commonly associated with conventional fence wire. This type of fencing is not recommended for horses unless electrified versions are used, and the owner is willing to accept some risk of injury.

High-tensile fencing is constructed with 11- to 14-gauge wire with a tensile strength of 170,000 to 200,000 pounds per square inch (psi) and breaking strengths of approximately 1,800 pounds. Wires are held in tension along posts spaced 16 to 90 feet apart. At installation, each wire is tightened with a permanent in-line strainer (Figure 11-5), and is set at 200 to 250 pounds of tension. In-line strainers should be placed near the middle of the fence line to provide the same tension in both directions.

Tension indicator springs, shown in Figure 11-6, are used to set and maintain the correct wire tension. One tension spring should be used on one wire per fence and set to the proper tension. The other wires can be tightened to the same tension by feel or sound (similar to tuning a guitar). The tension spring generally is set on the second wire. However, placing the tension spring on the top wire provides some additional give to minimize damage caused by falling tree limbs.

Electric Fencing

Electric fencing (Figure 11-6) is a safe and effective means of providing permanent and temporary fencing for most livestock. Their purpose is to supply sufficient electrical shock to any animal, whether livestock or predator, coming in contact with the wire, deterring them from continuing. Livestock unfamiliar with electric fences must be trained to respect and stay away from the electric wire.

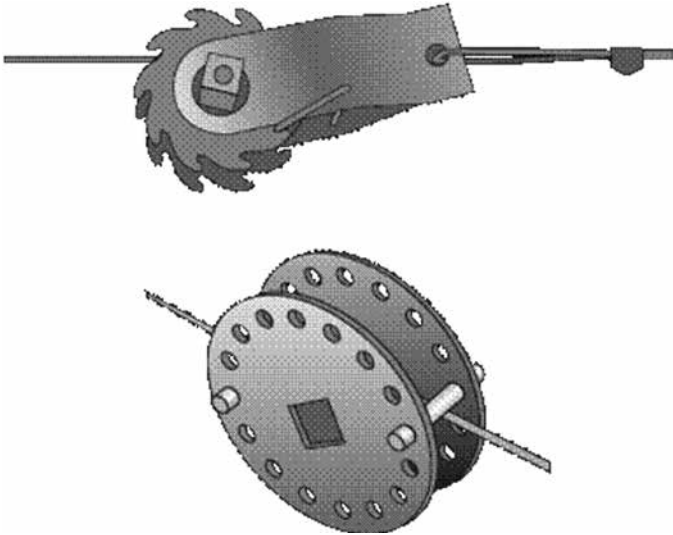

Figure 11-5. Tension in-line strainers.

Temporary Electric Fencing

Temporary electric fencing can be constructed from numerous materials. One of the more popular products consists of fine aluminum or stainless steel wires woven together with polyethylene fibers to form what is known as poly tape. This product comes in various colors with black being the most difficult for animals and humans to see. Brighter colors such as white or orange are much easier to notice and are recommended where visibility is especially important. Poly tape also is available in various wire densities. The maximum length for poly tape with a low wire density is about 1,200 feet. Poly tape with a high wire density can be used for longer runs.

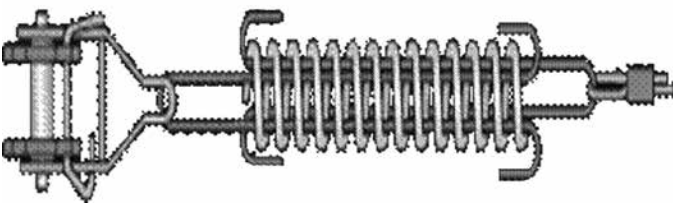

Figure 11-6. Tension indicator spring.

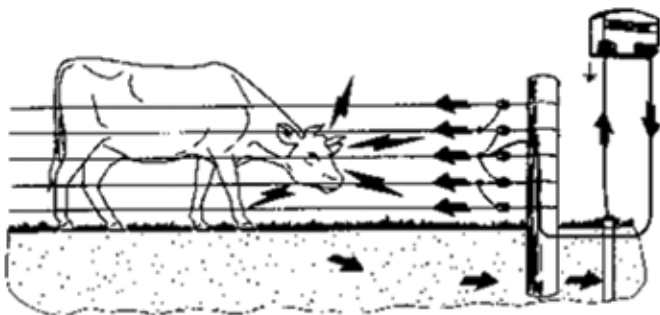

Figure 11-7. Electric fencing.

Permanent Electric Fencing

Permanent electric fencing generally consists of two or more strands of smooth wire. However, fences designed for small predator control may have as many as 10 or 12 strands. Alternate wires are hot. Other wires serve as grounded returns to the controller. The ground wire return design is recommended where the soil may be dry at times.

Permanent electric fences can be built from aluminum, stainless steel and high tensile wire. These types of wire conduct electrical charges for longer distances than poly tape. However, they are more difficult for animals to see. Animals will not be effectively trained to avoid electric wire unless they can see the wire when they feel the shock. Attaching strips of brightly colored cloth or plastic to the wire creates contrast and movement for easier visibility.

Electric Fence Equipment

Controllers

A controller, also called a charger or energizer, regulates the flow of energy in the fence wire by supplying pulses of high voltage electricity in short duration. An animal that comes in contact with an energized fence wire completes the circuit from the fence wire through its body, and then through the ground to the ground rod. The discomfort of the shock discourages the animal from further contact with the fence.

In most states, it is unlawful for any electric fence to be energized unless a controlling device regulates the charge on the fence wire. The controller must meet the safety standards of either the Underwriter's Laboratories, Inc. (UL) or the International Commission for Conformity Certification of Electrical Equipment (ICCC). Homemade or inexpensive, high impedance controllers should not be used. They may cause serious injury or death to both humans and livestock. Furthermore, the use of poorly designed controllers may result in grass fires around the fence.

Energizers

Joules and How Energizers are Rated

Joules are a measurement of energy. One joule is one watt for one second. A watt is volts multiplied by amps. A joule is the measure of kick of a pulse. However, each manufacturer measures and deter-

mines their own joule rating and many different factors are involved such as the following examples:

1. Was the rating determined at the energizer or on the fence line?
2. At what load was the measurement taken: 100 ohms; 500 ohms; 1,000 ohms; or even 50,000 ohms of resistance? (50,000 ohms means no fence connected to energizer.)
3. Was the test made at the end of a fence line, and if so, how long and of what size or gauge was the wire?

Until an independent testing agency does exactly the same test on all energizers, domestic or imported, the rating of fence energizer performance is nothing more than a general comparison.

Most energizers are rated with a minimum and a maximum joule rating for each model. The energizer will perform in this range, depending on the many different conditions that occur on each farm or ranch as outlined in the explanation above.

Livestock control using electric fencing depends on the following factors:

1. soil fertility and soil moisture
2. length of fence wire and size (gauge)
3. vegetative growth on fence line (such as weeds and grass)

NOTE: Use a fence energizer good enough to overcome any or all of the above factors.

Another misconception about performance of electric fences is how many miles of fence can be electrified. Many manufacturers advertise that their energizer will power 25 or even 50 miles of fence. The question should be not how much fence will it power, but if it will control animals under this condition. If performance in miles is a concern, a good rule of thumb is to multiply the joule rating by six. This calculation should give the approximate miles of fence for which the unit is designed.

Electric Fence Posts

Various kinds of posts are available for electric fences including wood, fiber glass, plastic, steel, or low-conductivity composites. Wood and steel posts require insulators to prevent short-circuiting of the fence through the posts. Plastic step-in posts work well for temporary fencing, but should be treated with ultraviolet inhibitors (UV treatment) to minimize deterioration in sunlight.

Wire

Steel wire longevity depends on the type and thickness of protective coating around the wire. Zinc is commonly used to cover (galvanize) steel wire to protect it from rusting. Zinc can be applied to steel wire in several ways and some are claimed to be superior to others. However, results of the American Society of Testing and Materials (ASTM) show no practical difference among galvanization methods.

Zinc coatings are measured in ounces of zinc per square foot of wire surface. The more zinc per square foot, the more years of wire use before rusting starts. The ASTM has established classes of zinc coatings for steel wire based on the number of years that galvanizing delays wire rusting under different climatic conditions. Class 1 has the lightest zinc coating, and Class 3 has the heaviest. Machinery, livestock and fire may damage the zinc coating, which results in wire that rusts sooner than undamaged wire. Steel wire may have less than a Class 1 coating, which is often referred to as regular galvanizing. Many local dealers stock steel wire with either regular or Class 1 coatings. Wire with a Class 3 coating may have to be specially ordered from the manufacturer.

Tying Off Corners

When tying off the wire at the strainer post, making a good strong self-locking knot is important, as shown in Figure 11-8.

Tying Off End Strain Insulators

A good strong knot also must be made when tying off end strain insulators. Using a simple twist

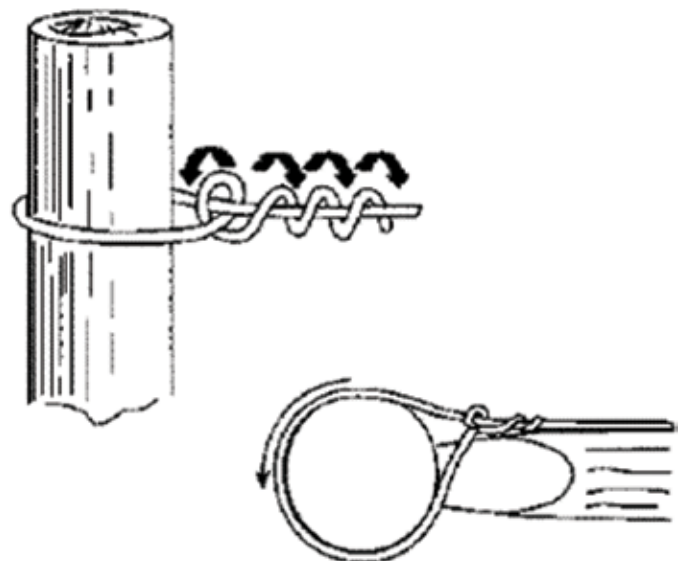

Figure 11-8. Tying off corners.

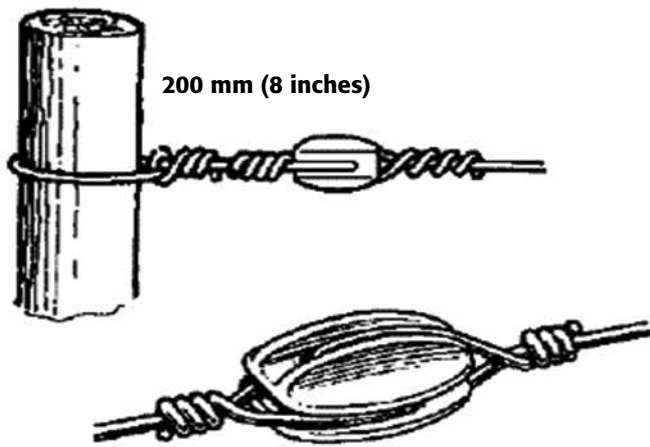

Figure 11-9. Tying off end strain insulators.

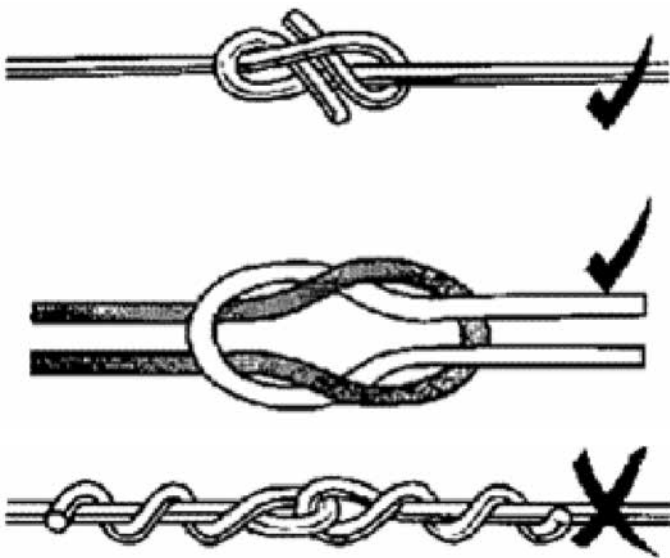

Figure 11-10. Wire splicing.

knot, wrapping the wire around itself at least four times and keeping the insulator within 8 inches of the strainer post (Figure 11-9), will prevent animals from pushing between the insulator and strainer post.

When tying off end strain insulators, the wires always should be tied so that they strain from the center of the insulator.

For most fences, 12 ½-gauge high-tensile wire is recommended for use. For long lead-out wires or corrosion problems (from salt spray and other elements), a heavier gauge wire such as 10-gauge or 8-gauge should be used.

Wire Splicing

Incorrectly joined wires can be a major cause of power leakage. When joining wires together in the middle of a fence line, use either a figure eight knot or a reef knot (Figure 11-10).

Lead Outs

At least one 12 ½-gauge double-insulated cable should be used as the lead out. Two or more joined in parallel are better, because this configuration lowers the resistance of the wire. Table 11-1 shows wire resistance for certain wire diameters. The resistance numbers show the ohms resistance of galvanized steel fence over one mile. The lower the ohms, the lower the resistance. Different metal types have varying resistances. For example, one mile of 11-gauge aluminum wire has only 18 ohms resistance. Aluminum wire makes an excellent lead out through very long distances, but it is at least double the price of conventional steel wires.

Lead outs can be run either overhead or underground. Underground is preferred because of less chance that high vehicles will interfere with the lead out. Where lead outs are being run underground in high traffic areas, the lead out cable or cables should be run through irrigation tubing as an extra safeguard against damage. Using insulated cable as a lead out has several advantages:

- No chance of shorting out on sheds or the ground.
- Totally waterproof, easily installed, and long lasting.

The longer a lead out wire is the greater its resistance. Resistance of the wire is one of the biggest problems to overcome. Larger diameter wires create less resistance and; therefore, have a better current flow.

Practical Suggestions for Long Lead Outs

- Use bigger diameter wires. For example, use 10-or 8-gauge wires instead of a 12 ½-gauge.
- Run wires in parallel. Run two or more wires along the fence line side by side, and connect these wires together at each strainer post. (See the diagram in Figure 11-11.) Two wires together will half the resistance and three will reduce it to only one-third.

Table 11-1. Wire Resistance.

Wire Diameter (Gauge)	Resistance (Ohms per mile)
8	22.5
10	35
12 ½	56
14	87
16	145

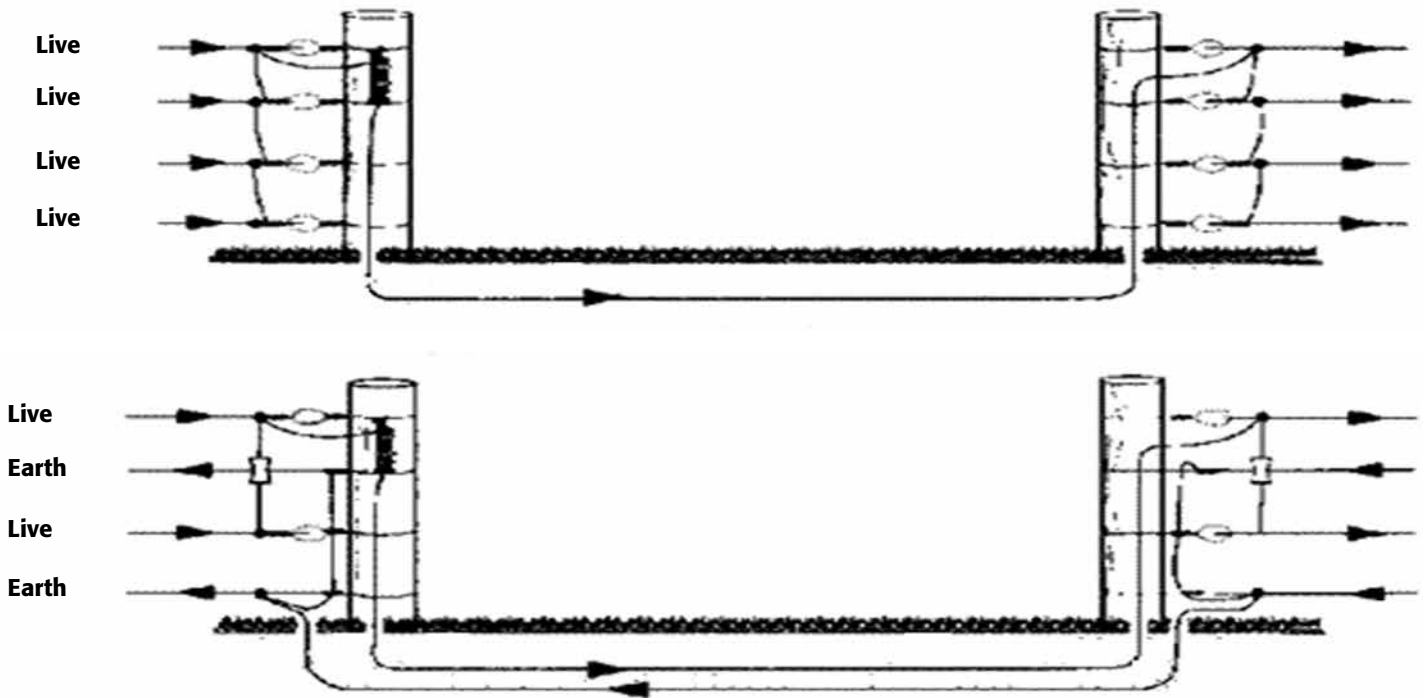
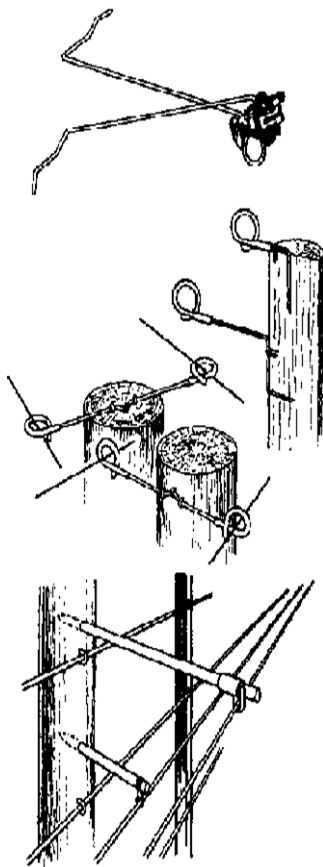

Figure 11-11. Practical suggestions for long lead outs.



Wire Offsets

These offsets are attached by twisting them around fence wires. They come with either porcelain or pinlock insulators.

Steel Offsets

These offsets are used for driving into timber posts. They can be affixed to the top or the side of the post and driven directly into the posts.

Fiberglass Offsets

These offsets can be driven into timber posts (drill pilot holes first) and can also be used for most concrete posts. They are available in 12 inch lengths and come with either a fixed nylon clip or a moveable steel clip.

Figure 11-12. Offsets for electrifying conventional fences.

- Use aluminum wire for lead outs. Aluminum wire has only one-sixth the resistance of steel wire. It does not have the same tensile strength, however, so a minimum diameter of 11-gauge is recommended.

Electrifying Conventional Fences

Using offsets (also known as standoffs or outriggers), such as those shown in Figure 11-12, to run electrified wires has the following benefits:

- Stock pressure on existing conventional fences is reduced, which will extend the life of old fences and add years to new ones.
- Old conventional fences can be rejuvenated by running an electrified wire on both sides. The wire can be run either on the top of the posts to stop animals from leaning over the fence, or an offset can be attached to the fence at about two thirds of the height of the animal being controlled. An offset in this position will stop animals from rubbing against the fence.
- When attaching offsets to an existing fence, checking that all wires are in good condition is important. Broken wires can come in contact with the electrified wires and cause shorts. Outriggers should be placed no more than 16 to 22 yards apart. The offsets should be placed as close to the line posts as possible for rigidity.

Gateways

When crossing gateways, insulated 12 ½-gauge cable buried at least 12 inches underground is recommended. In heavy traffic areas, the insulated cable should be run through irrigation tubing for extra protection before it is buried. The ends of the tubing should be turned down to prevent water from entering.

Overhead crossings are not recommended because they are susceptible to damage.

When installing an electric fence, the following points should be considered:

- Attach each end of the insulated cable to the fence line with joint clamps.
- If the fence system is a fence ground return system, run a ground cable plus the live cable under the gateway.
- Always use 12 ½-gauge cable, as it is more conductive than 16-gauge cable.
- Never use household electrical cable under gateways.
- Never use spring gates or tape gates instead of insulated cable to carry the current across the gateway.
- Where there is a ground cable and a live cable crossing a gateway, mark the cables to prevent cross-connection.
- Always allow extra cable, to avoid joins.

Flood Gates

Flood gates, shown in Figure 11-13, are ideal for use in creeks, river beds and other areas prone to flooding.

To install a flood gate, follow these steps:

1. Strain a wire between two posts (one on either side of the creek).
2. Clamp on lengths of galvanized chain hung at intervals of 6 inches. For large animals, this can be increased to 12 inches. The length of the chain is kept to 12 inches above the lowest average water level.
3. Connect the flood gate controller (energy limiter) between the fence and the flood gate, which limits the amount of power on the flood gate during a flood so the remainder of the fence continues to have a high voltage.

Where a likelihood exists of water levels remaining high for extended periods of time, placing a cutout switch is recommended.

Lightning Protection

Both the input (120 volt source) and the output (fence) side of the charger need to be protected from lightning. The following two options would protect the input side.

1. Use a power surge protector (MPS). Some studies have shown that the majority of damage is caused by surges from the utility side. The power surge protector is the easier of the two to install. This simple device plugs into the grounded receptacle with the charger cord connected to it.
2. Since some chargers do not have external access to the fuses, the second option to consider is to replace the original plug with a fused plug (MFP). This fused plug has two internal fuses that can be easily replaced if a problem should occur.

A lightning diverter and choke coil (MWLA) for the output side is shown in Figure 11-14. The output side usually takes the blunt force of a lightning strike to the fence line. Most chargers have some type of lightning surge protection built into their circuitry. However, if a lightning strike gets past this protection, repairs or replacement can be costly. Since lightning naturally seeks the ground by the path of least resistance, this discussion centers on giving it an easier route than through the charger.

Multiple hot wire jumpers should be made on the fence at a location where any lightning surge energy has to pass through the diverter and choke before reaching the charger. Proper installation of

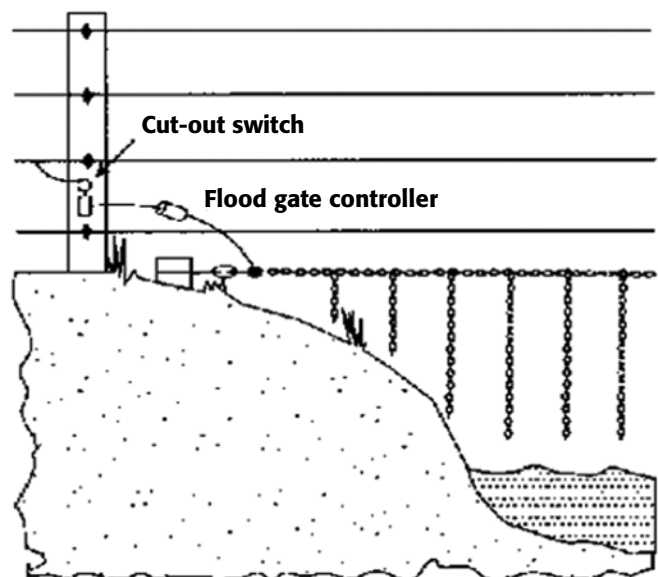

Figure 11-13. Flood gates.

the lightning diverter is essential to its operation in the event of a lightning strike on the fence line.

For best results, perform the following actions:

1. Install the diverter close to the charger (minimum of 50 foot between beds).
2. Use a choke coil in very close proximity to the diverter; the closer the better.
3. If installing the fence leaves enough of a leg of wire after crimping around the end or corner post, pass the wire through the diverter and connect it to the choke coil. Otherwise, use a split bolt line tap to connect to the main fence line.
4. Mount the lightning diverter and choke coil to the post as shown in Figure 11-14. Unscrew the top nut on the diverter and lay the wire from the fence line in the top slot and connect it to the choke coil. Tighten both connections.
5. Attach the wire from the charger to the other end of the choke coil.
6. Install the ground bed. Run the wire from the bottom of the diverter to the ground bed and insulate it where it crosses the wires.

Fencing Examples

Permanent-offset

Figure 11-15 shows a possible permanent offset setup that utilizes both woven wire and high tensile offset wire, which would make an excellent sheep and goat fence.

The following items are advantages of permanent offset fencing:

- Smaller energizers can be used that are less costly and safer. High joule output units are normally used to overcome voltage drops due



Figure 11-14. MWLA lightning protection.

to vegetative contact. This system can eliminate or reduce that need.

- Cuts down on maintenance and voltage checks.
- Improves predator and guard animal control.
- Decreases incidence of heads being caught in woven wire.
- Reduces the possible liability risk of public access since contact with a hot wire on the inside of a boundary fence means that the public must be trespassing.

One disadvantage of permanent offset fencing is that the cost of the material is more expensive if starting from scratch.

Permanent High Tensile Smooth Wire

The least costly permanent fence per year of useful life utilizes only high-tensile (HT) smooth wire. Wire can be secured to wood posts or T-posts and energizing the wire can be all hot or alternate variations of hot and ground, shown in Figure 11-16.

The following items are some of the advantages of permanent high-tensile smooth wire fences:

- Low-cost boundary fence
- Easiest permanent fence to install
- Economical for straight and level fences
- Good for subdividing pastures or paddocks

The following items are some of the disadvantages of permanent high-tensile smooth wire fences:

- Less reliable for predator and livestock control
- Higher drain on energizers from vegetation
- Increased maintenance cost and management time.

Temporary Electric Fencing

Electric net or hot tape, rope, twine or fine wire can be used for very effective short-term boundary control. Portable fences provide flexibility in pasture management and are ideal for short-term animal control or rotational grazing. Easily transported, constructed and maintained, portable fences are an effective temporary fencing solution for a range of animals and situations. Figure 11-17 shows the different post options available.

Strip Grazing

Temporary fencing gives the versatility to strip graze; make temporary paddocks or pens; and pro-

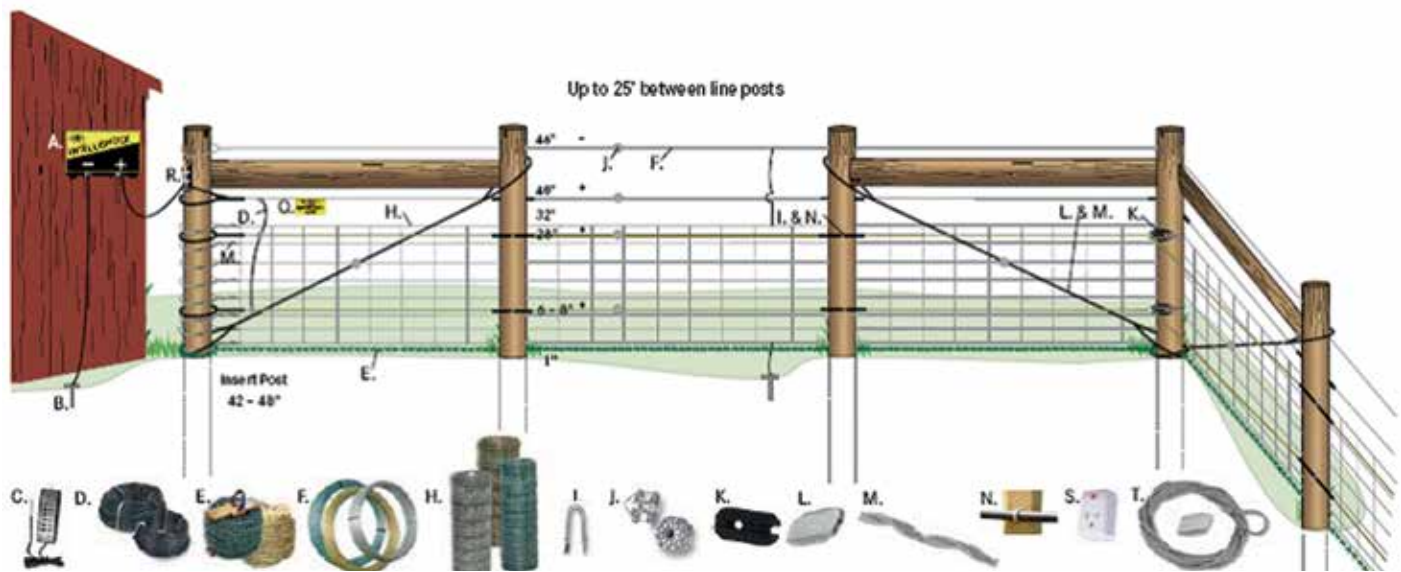

Typical parts involved:

- | | | | | |
|---------------------------|--------------------------------|------------------------|-----------------------------------|------------------------------|
| A. Energizer | B. Ground rod (6' 5/8") | C. Fence tester | D. Insulated cable | E. Barb wire |
| F. HT smooth wire | H. HT woven | I. Staples | J. Daisy or Hayes strainer | K. Terminal insulator |
| L. Gripple lock | M. Twist lock | N. Supatube | Q. Warning sign | R. Cut-out switch |
| S. Surge protector | T. Speed brace | | | |

Figure 11-15. Diagram showing a possible permanent offset setup that utilizes both woven wire and high-tensile offset wire.

protect trees, gardens or other areas from unwanted damage caused by wildlife and other animals.

The suggested equipment and strip grazing method are illustrated in Figure 11-18 and 11-19.

Intensive grazing has a number of advantages:

- Ensures maximum use of available pasture, particularly in times of feed shortage.
- Provides enhanced pasture growth and more controlled, even grazing.
- Allows areas not normally fenced, such as cropping paddocks or road frontages, to be quickly and easily fenced and grazed.
- Provides improved financial returns from increased production.
- Intensive grazing is ideally suited to cattle and sheep, but also can be used for other animals such as horses, goats and deer. Cattle can be grazed using a single wire. If goats and cattle are being grazed together, then two wires may be required.

Intensive grazing also has disadvantages:

- Less reliable for predator and livestock control
- Higher drain on energizers from vegetation
- Increased maintenance cost and management time

Planning

Constructing a high quality fence is important to ensure less problems in the future.

Electric fences do not need to be constructed to the same strength as conventional fences because they provide a psychological barrier rather than a physical one. They should still, however, be soundly constructed to withstand the rigors of use.

The overall layout of the electric fencing system deserves careful planning to ensure receiving the best possible advantages from it. The time spent in planning helps find and repair any faults or shorts quickly and assists with stock management.

Figure 11-20 gives an example of a basic plan of an ideal fence set on a flat, rectangular farm.

Consideration of the same principles should also be applied on hill country or less favorably shaped farms.

To make a basic plan, place a sheet of clear plastic over an aerial photograph of the property and draw in the old and planned fence lines. This activity helps to pinpoint things producers needed to know before starting, such as the following items:

- The overall length of the proposed new electric fencing and existing fencing to be electrified.
- The position of laneways and gateways.
- The location and length of supply lines from the energizer to the electric fence.
- The placement of cutout switches.
- Whether mains, battery or solar powered energizers will be needed.

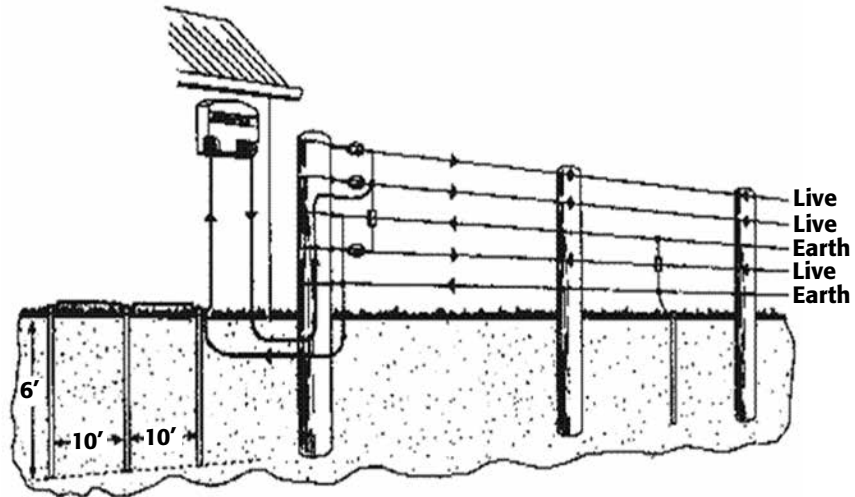
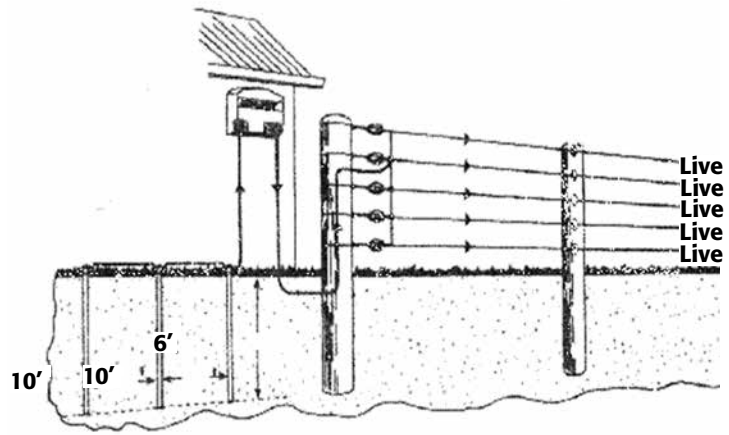
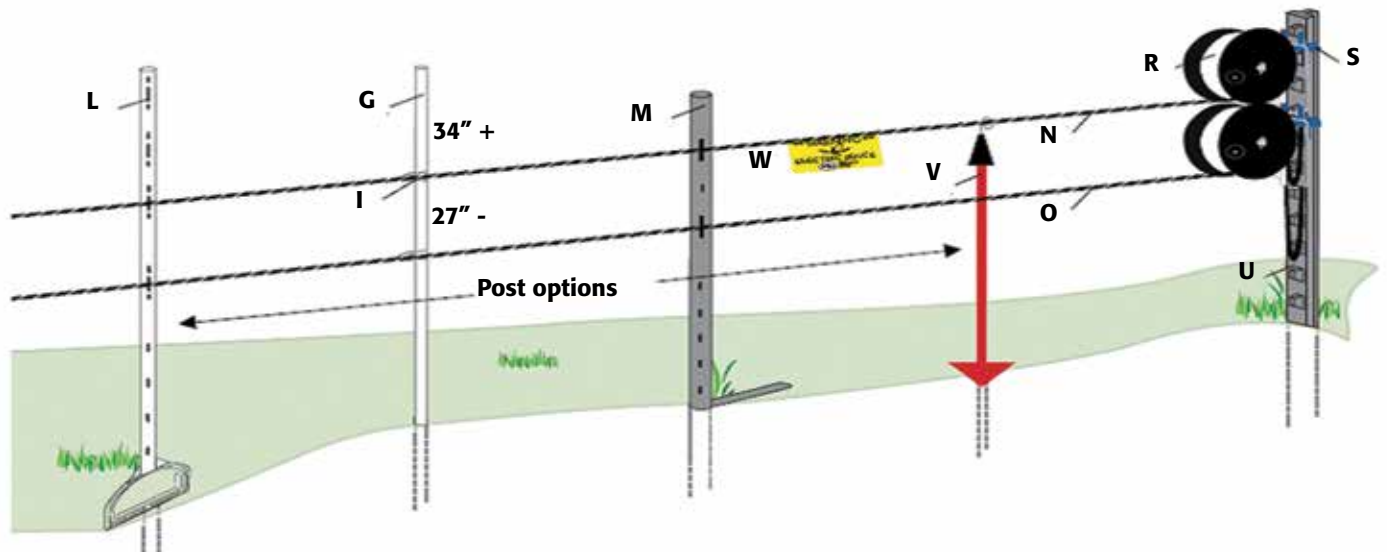

Figure 11-16. Live-live versus live-earth.



G. Fiberglass post
O. Plastic tape
W. Warning sign

I. Metal clips
R. Reel

L. Tread in post
S. T-post bracket

M. Insultimbers
U. T-post

N. Plastic rope, twine
V. Pigtain tread in post

Figure 11-17. Post options for electric fencing.



Mini Reel

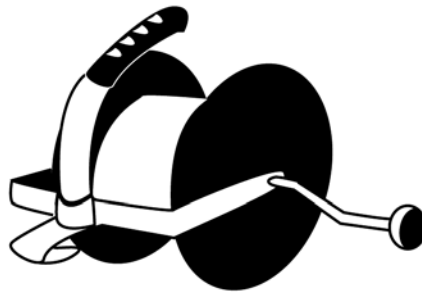

Single Line Reel

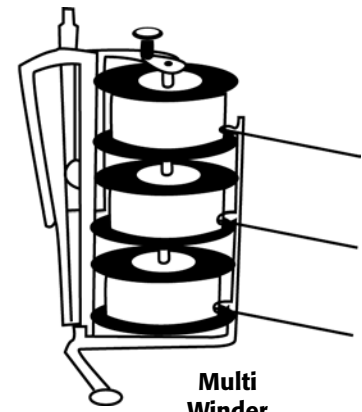

Multi Winder

Figure 11-18. Strip grazing equipment.

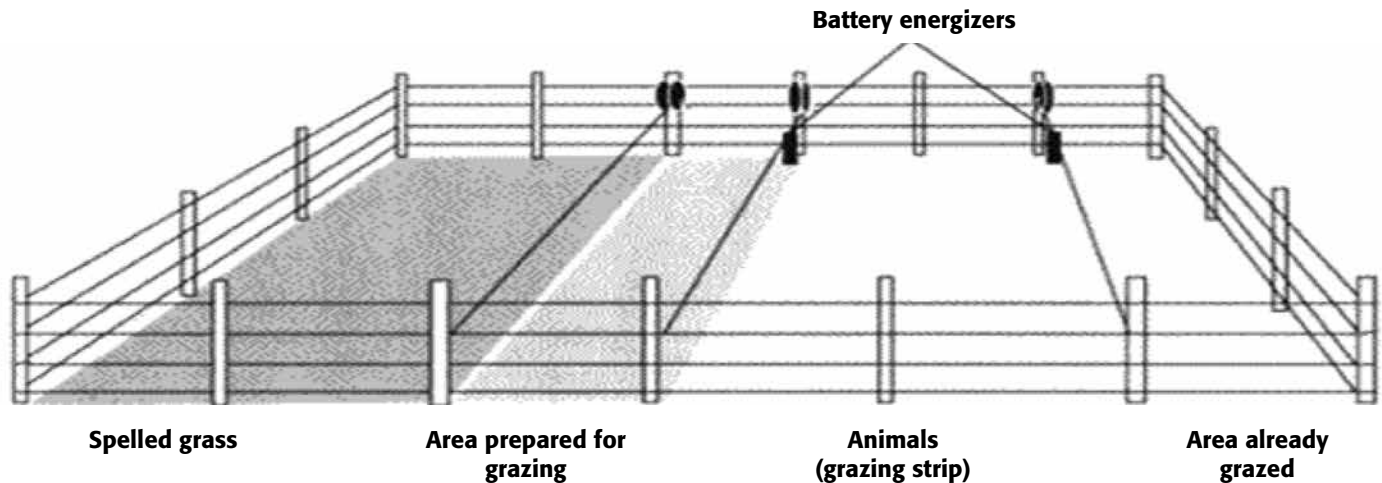

Figure 11-19. Suggested strip grazing method using electric fencing.

- What size energizer, or in some cases, the number of energizers required.
- The location of the energizer.
- The location of the ground.
- The direction the current flows. Knowing this direction will help with maintenance and fault finding.

Fencing Costs

Tables 11-2 and 11-3 show comparisons of various fencing costs for both perimeter fencing and interior fencing.

Paddock Size and Shape

Whenever possible, paddocks should be made square. This configuration allows better pasture management with more even grazing. Long, narrow paddocks create more walking and footpaths, while the backs of the paddocks are often undergrazed.

Where possible, a laneway down the center or side of the subdivision should be incorporated. This will assist with stock movement and access.

The size of the paddocks is not as vitally important as the number of paddocks. Obviously, both are relative to the size of the farm and the number and types of animals stocked. The number of paddocks is important so it allows for intensive grazing, locking up of hay and silage and the flexibility of longer rotations during times of feed shortage.

Subdivision of hilly terrain deserves careful planning. Wherever possible, fence lines should follow the contour of the land so sunny slopes, shady slopes and flat land are all kept separate. This configuration allows for better pasture management, especially in areas prone to erosion.

Strip grazing also can be incorporated to gain even better pasture management. See the diagram in Figure 11-19.

Suggested Intensive Grazing Method

For intensive grazing, the fence generally is moved daily, and the distance it is moved is based

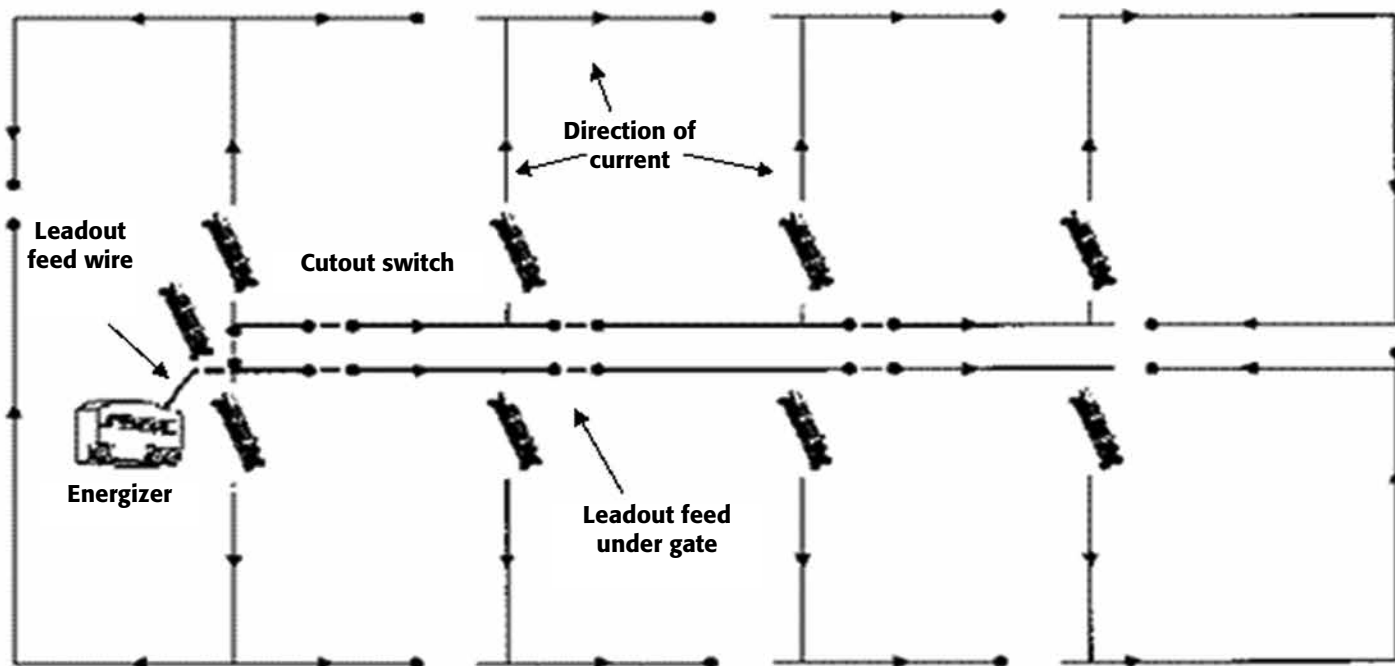

Figure 11-20. Basic layout plan for an electric fencing system.

upon the number of animals being grazed and the quality and quantity of available pasture.

A back fence also should be erected to stop animals from returning to the areas already grazed, thus allowing a quicker recovery of the pasture.

Goats can be grazed in the same manner as cattle, but may require three wires instead of a single wire. Alternatively, portable netting also may be used.

For any other animals being grazed, wires can be set up depending on the heights of the animals.

Polytape, maxi-shock, polywire and/or polyrope are ideally suited for temporary fencing since they are extremely flexible and light, yet very strong and easily rewound onto fence reels.

References

- Estimated Cost For Livestock Fencing. (1999). Iowa State University Cooperative Extension Service.
- Fencing Materials for Livestock Systems. (2003) Virginia Tech Cooperative Extension Service. Pub No. 442-131, Revised.
- Managed Grazing Systems and Fencing for Distribution of Beef Manure. Publication EQ379. <http://muextension.missouri.edu/explore/envqual/eq0379.htm>
- Planning Fencing Systems for Intensive Grazing Management. University of Kentucky: ID-74. <http://www.ca.uky.edu/agc/pubs/id/id74/id74.htm>
- Rotational Grazing. Publication ID-143. <http://www.ca.uky.edu/agc/pubs/id/id143/id143.htm>
- University of Maryland. <http://sheepandgoat.com/fencing.html>

Additional Company Resources

Gallagher
130 West 23rd Avenue
North Kansas City, MO 64116
<http://www.gallagherusa.com/pf.manual.aspx>

Kencove Fence Supplies
344 Kendall Road
Blairsville, PA 15717
<http://www.kencove.com/Premier1>
2031 300th Street
Washington, IA 52353
<http://www.premier1supplies.com>

Southwest Power Equipment
26321 Hwy 281 North
San Antonio, TX 78260
<http://www.swpowerfence.com>

Tru-Test
328 Grant Road
Mineral Wells, TX 76067
<http://www.speedrite.com/>

Power Flex Fence
<http://www.powerflexfence.com>

Pasture Management Systems, Inc
<http://www.pasturemgmt.com>

Twin Mountain Fence
<http://www.twinmountainfence.com>

Table 11-2. Perimeter fencing costs on an 80 acre farm (Perimeter = 7,467 ft).

<i>Item</i>	<i>Woven Wire</i>	<i>Barbed Wire 6 strand</i>	<i>High Tensile (nonelectric) 8 strand</i>	<i>High Tensil (electric) 5 strand</i>
Estimated useful life (yr.)	20	20	25	25
Initial cost	\$7,070	\$7,696	\$4,946	\$4,285
Average annual maintenance (% of initial cost)	8%	8%	5%	5%
Depreciation	63	68	35	30
Interest on investment	124	129	100	94
Maintenance	100	109	44	38
Total cost per year*	287	306	179	162
Total cost per foot/year	0.22	0.23	0.14	0.12

* Annual average ownership cost by fence type (based on a 1,320 foot fence).

Table 11-3. Interior fencing costs using electric polywire fence.

<i>Item</i>	<i>Amount Needed</i>	<i>Cost Per Unit</i>	<i>Total Cost</i>
Wood posts (4 inch diameter)	2	\$9.50	\$19.00
Composite post (1 1/8 x 54 inch)	33	\$4.00	\$132.00
HT wire 12.5 ga	2 x 1,320 ft.	\$0.024	\$63.36
Energizer (priced over 4 yrs)	1/4	\$500.00	\$125.00
Cut-out switch	1	\$9.50	\$9.50
Grounding/Lightning rod	4	\$10.25	\$41.00
Labor estimate	2 hrs	\$15.00	\$30.00
Total*			\$420.00
Total per foot			\$0.32

*Based on a 1,320-foot fence.